

CAST IRON GLOBE VALVE ANGLE DIN 3202 F32, PN 6

Материал cast iron EN-JL1040; DIN GG25
 Налягане PN 6
 Размер DN 15 - 300

DESCRIPTIONS

Globe valve angle type, flanged connection with shut off, regulating or screw down non return (SDNR) function. Metal sealing. Rising stem type.

MEDIA

- Fuel oil, lubricating oil and flammable hydraulic oil. Cargo oil.
- Seawater and freshwater.

VARIANTS

- Regulating disc.
- Stainless steel trim.

OPTIONS

Spring for SDNR; PN6; PN10

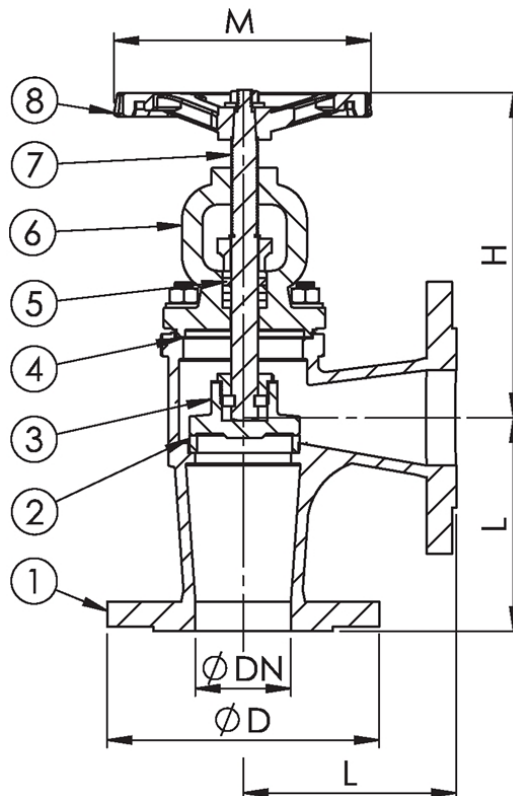

No.	Part	Material
1	Body	Cast iron EN-JL1040 (GG25)
2	Seat	Stainless steel 1.4301
3	Disc	Cast iron EN-JL1040 (GG25)/St. Steel 1.4301
4	Gasket	Graphite
5	Gland packing	Graphite
6	Bonnet gasket	Cast iron EN-JL1040 (GG25)
7	Stem	PTFE
8	Handweel	Cast iron EN-JL1040 (GG25)

Specifications	
Standart:	DIN 3202 F32
Flange standard:	EN1092-2
Face to face standard:	EN558, Series 1
Bonnet connection:	Bolted
Execution:	Angle
Connection type:	Flanged
Operation:	Handwheel
Actuation:	Multiturn
Tmax	120 °C

Dn	Pressure rating	Connection	L	D	P	N x d	H	M	Weight (kg)
15	6	6	90	80	55	4 x 11	173	120	4
20	6	6	95	90	65	4 x 11	173	120	4,5
25	6	6	100	100	75	4 x 11	190	120	5,2
32	6	6	105	120	90	4 x 14	190	120	6,7

**CAST IRON GLOBE VALVE ANGLE DIN 3202
F32, PN 6**

Материал cast iron EN-JL1040; DIN GG25

Налягане PN 6

Размер DN 15 - 300

Dn	Pressure rating	Connection	L	D	P	N x d	H	M	Weight (kg)
40	6	6	115	130	100	4 x 14	225	140	9,6
50	6	6	125	140	110	4 x 14	218	140	12
65	6	6	145	160	130	4 x 14	246	140	16
80	6	6	155	190	150	4 x 18	274	160	21
100	6	6	175	210	170	4 x 18	303	160	33
125	6	6	200	240	200	8 x 18	310	200	43
150	6	6	225	265	225	8 x 18	360	200	70
200	6	6	275	320	280	8 x 18	488	400	110
250	6	6	325	375	335	12 x 18	550	400	160
300	6	6	375	440	395	12 x 18	786	500	280