

GLOBE VALVE CAST STEEL ANGLE DIN 3202 F32, PN 10

Материал steel 1.0619; DIN GS-C25

Налягане PN 10

Размер DN 15 - 300

DESCRIPTIONS

Globe valve with shut off or screw down non return (SDNR) function. Metal sealing. Rising stem type.

MEDIA

- Fuel oil, lubricating oil and flammable hydraulic oil. Cargo oil. Non-flammable hydraulic fluid.

- Boiler feedwater, condensate. Seawater and freshwater.

VARIANTS

Regulating disc.

Screw down non return discs - SDNR

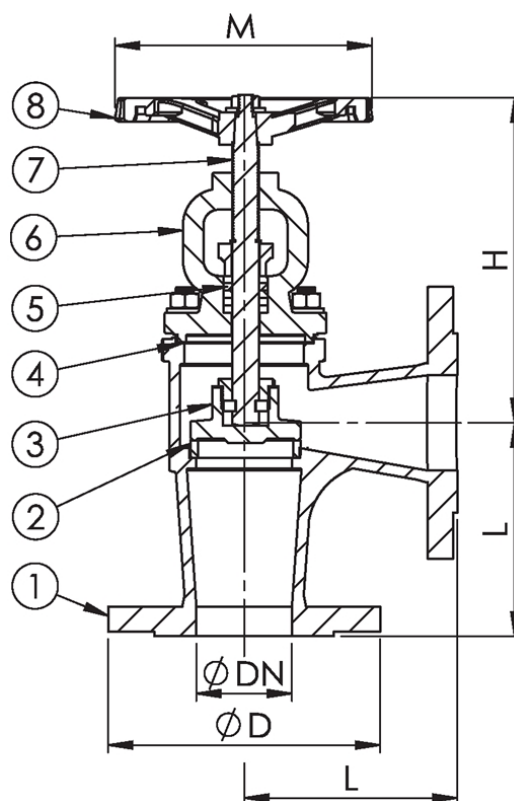

No.	Part	Material	Specifications	
1	Body	Cast Steel 1.0619 (WCB)+13Cr	Standart:	DIN 3202 F1
2	Seat	Cast Steel 1.0619 (WCB)+13Cr	Flange standard:	EN1092-2
3	Disc	Cast Steel 1.0482 (A105)+13Cr	Face to face standard:	EN558, Series 1
4	Gasket	SS+Graphite	Bonnet connection:	Bolted
5	Gland packing	Graphite	Execution:	Angle
6	Bonnet gasket	Cast Steel 1.0619 (WCB)+13Cr	Connection type:	Flanged
7	Stem	Stainless steel EN 1.4021 2Cr13	Operation:	Handwheel
8	Handweel	Ductile iron EN-JS1025 (GGG40.3)	Actuation:	Multiturn
			Tmax	From -29 °C to 425°C

Dn	Pressure rating	Connection	L	D	P	N x d	H	M	Weight (kg)
15	10	10	90	95	65	4 x 14	165	120	4,5
20	10	10	95	105	75	4 x 14	165	120	5,5
25	10	10	100	115	85	4 x 14	180	140	7
32	10	10	105	140	100	4 x 18	180	140	9

GLOBE VALVE CAST STEEL ANGLE DIN 3202 F32, PN 10

Материал steel 1.0619; DIN GS-C25

Налягане PN 10

Размер DN 15 - 300

Dn	Pressure rating	Connection	L	D	P	N x d	H	M	Weight (kg)
40	10	10	115	150	110	4 x 18	215	160	12
50	10	10	125	165	125	4 x 18	230	160	16
65	10	10	145	185	145	8 x 18b	245	180	22,1
80	10	10	155	200	160	8 x 18	295	210	27,2
100	10	10	175	220	180	8 x 18	325	225	44
125	10	10	200	250	210	8 x 18	360	250	70
150	10	10	225	285	240	8 x 22	425	300	92,5
200	10	10	270	340	295	8 x 22	505	400	178

*b - Where steel flanges are required with 4 holes, these may be supplied by agreement between the supplier and client