

# STEEL CHECK VALVE DIN PN 40

Материал steel 1.0619;DIN GS-C25

Налягане PN 40

Размер DN-50-400

## DESCRIPTIONS

Check valve with metal sealing, flanged connection and bolted cover.

## MEDIA

- Steam. Fuel oil, lubricating oil and flammable hydraulic oil. Cargo oil. Non-flammable hydraulic fluid.

- Boiler feedwater, condensate. Seawater and freshwater. Also for installation in vertical pipelines. Upwards flow only.

## VARIANTS

Other materials on request

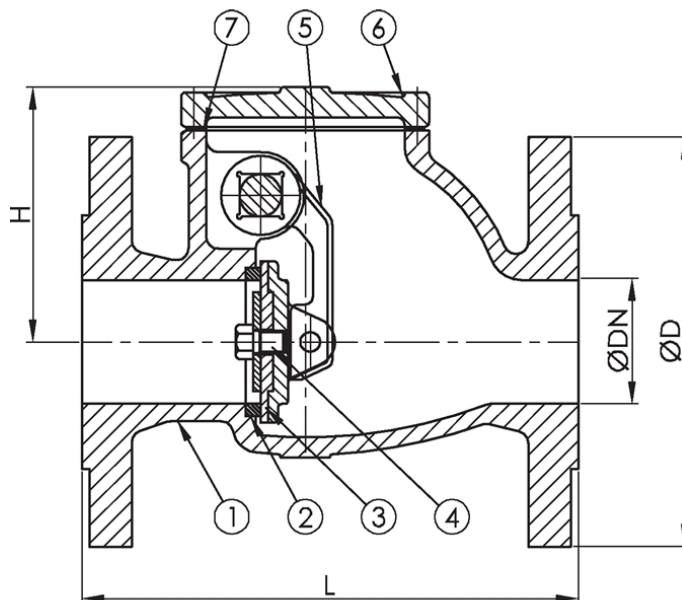

No.	Part	Material	Specifications	
1	Body	Cast steel 1.0619 (WCB)	Standart:	DIN 3202 F1
2	Body seat	Stainless steel 1.4301 (AISI304)	Flange standard:	EN1092-2
3	Disc sealing	NBR	Face to face standard:	EN558, Series 1
4	Stem	Stainless steel 1.4021 (AISI420)	Bonnet connection:	Bolted
5	Disc, hinge arm	Cast steel 1.0619 (WCB)	Execution:	Straight
6	Cover	Cast steel 1.0619 (WCB)	Connection type:	Flanged
7	Bonnet gasket	NBR bonded aramid	Operation:	Non-return valve
			Actuation:	Self Return
			Tmax: [°C]	300 °C

Dn	Pressure rating	Connection	L	D	P	N x d	H	Weight (kg)
50	40	40	200	160	125	4 x 18	120	18
65	40	40	240	180	145	8 x 18	135	22
80	40	40	260	195	160	8 x 18	145	39
100	40	40	300	215	180	8 x 22	186	50

## STEEL CHECK VALVE DIN PN 40

Материал steel 1.0619;DIN GS-C25

Налягане PN 40

Размер DN-50-400

Dn	Pressure rating	Connection	L	D	P	N x d	H	Weight (kg)
125	40	40	350	245	210	8 x 26	200	71
150	40	40	400	280	240	8 x 26	214	95
200	40	40	500	340	295	12 x 30	300	198
250	40	40	600	405	355	12 x 33	340	305
300	40	40	700	460	410	16 x 33	380	503
400	40	40	900	580	525	16 x 39	464	816